



**Kerala State Drugs and Pharmaceuticals Ltd**  
**(A Govt. of Kerala Enterprise)**  
**KALAVOOR, ALAPPUZHA**

Phone :0477-2258184 (Extn:207) ; Email :ksdprmqt@gmail.com  
Web :ksdp.co.in

**KSDP/PS/F-ST/2023-24/20000027/T-24**

**21-12-2023**

**Notice re-inviting sealed tender for the supply of 20ml Vials - 80000 Nos**

Quotations are invited for the supply of undermentioned goods/ services as per the attached specifications on FOR destination basis at our factory site at Kalavoor,Alappuzha, Kerala state

SI No.	ITEM CODE & DESCRIPTION	UNIT	QUANTITY	EMD	TENDER FEES
1	41100002 TYPE I GLASS VIALS - CLEAR - 20ML	Numbers	80,000 NOS	Rs. 4496	Rs.1008

Quotations should be submitted as per the Proforma given below on your letter head.

SI No.	Name of item	Make	Rate per unit (including freight, if any)	GST %	Offer validity	Remarks, if any
--------	--------------	------	---	-------	----------------	-----------------

**Due Date/Time : 29-Dec-23 / 03.00 PM**

**Opening Date/Time : 30-Dec-23 / 03.00 PM**

Separate demand drafts should be submitted for Tender fee & EMD in favour of Kerala State Drugs & Pharmaceuticals Ltd payable at Alappuzha, Kerala.

Offer validity\*: Minimum 7 days offer validity from the date of closure of bid submission. Quotation received with offer validity less than 7 days from the date of closure of bid submission will be entirely rejected.

Please Submit Your Lowest Offer in a Sealed Cover Superscribing "SEALED TENDER FOR THE SUPPLY OF 20ML VIALS - 80000 Nos. DUE ON 29.12.2023 TENDER ID:KSDP/PS/F-ST/2023-24/109"on or before 29.12.2023, 03.00 PM to the Office of the Managing Director, Kerala State Drugs & Pharmaceuticals Ltd, Kalavoor - P.O, Alappuzha - 688522 in two cover system.

1st cover: should comprise of technical bid. Must submit COA, EMD&TC (Provide proof for exemptions of EMD & TC, if any) & other relevant documents for technical evaluation.

2nd cover: should comprise of price bid.

Quotation received in any other mode or not as per the prescribed format will be rejected.

**TERMS & CONDITIONS**

- 1.Payment terms :- 30 days after the receipt of the material along with documents, subject to QC approval.
- 2.Mode of payment:- E-Payment.
- 3.Delivery Period:- Supply should be effected within 15 days on award of PO

**HOD - Purchase**



KERALA STATE DRUGS AND PHARMACEUTICALS LTD,  
KALAVOOR PO, ALAPPUZHA, KERALA-688522

**Packaging Material Specification**

Name of the Material: **20ML VIAL**





SOP No:	KSDP/SOP/SPEC02	Spec. No:	VIAL-20ML
Effective date:	01/01/2019	Revision No:	01

20 ml flat bottomed vials made of USP type I Flint glass of uniform surface finish without having bubbles and blow holes or apparent strains.

Height	: (57.0-58.0)mm
Over flow volume	: (26-28)ml
Outer body diameter	: (31.60-32.40)mm
Mouth OD	: (19.70-20.10)mm
Mouth ID	: (12.50-12.90)mm
Neck ID	: (16.60-17.40)mm
Height from base to constriction	: (35.25-35.75)mm
Weight	: (27-28) gm

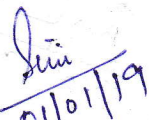
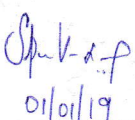
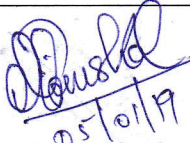
The vial should comply with all chemical tests specified in the Indian pharmacopoeia. The supplier should submit samples physically and it should pass the performance test.

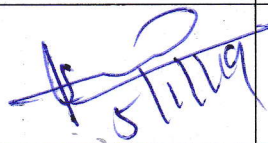
Drawing attached

Prepared by	Checked By	Reviewed By	Reviewed By	Approved By	Authorized By
Jr. Manager QA	QC Head	Asst Manager, Production	Dy. Manager, Production	Production Head	QA Head
 01/01/19	 01/01/19	 05/01/19	 05/01/19	 05/01/19	 05/01/19

MASTER COPY

MASTER COPY



**KERALA STATE DRUGS AND PHARMACEUTICALS LTD,  
KALAVOOR PO, ALAPPUZHA, KERALA-688522**

Name of the Material: **20ML VIAL**

SOP No:	KSDP/SOP/SPEC02	Spec. No:	VIAL-20ML
Effective date:	01/01/2019	Revision No:	01

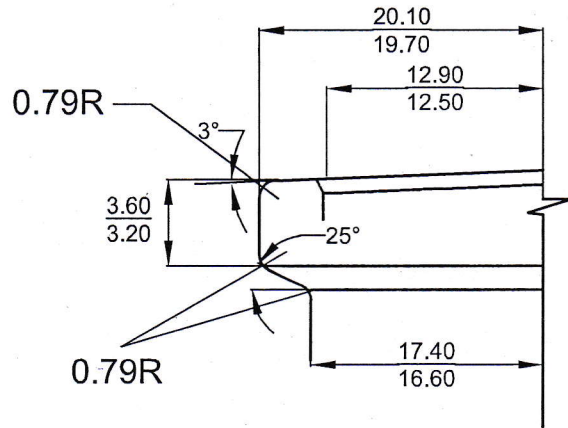
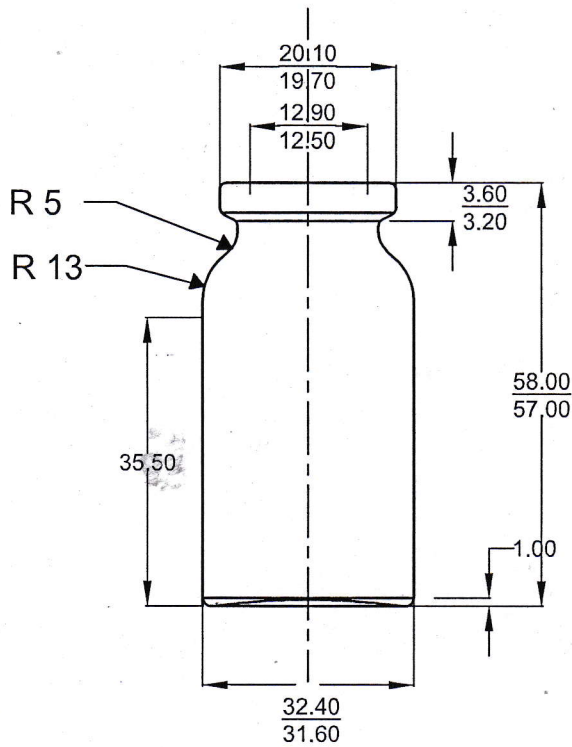

**NECK FINISH DETAIL**

Prepared by	Checked By	Reviewed By	Reviewed By	Approved By	Authorized By
Jr. Manager QA	QC Head	Asst Manager, Production	Dy. Manager, Production	Production Head	QA Head
<i>[Signature]</i> 01/01/19	<i>[Signature]</i> 01/01/19	<i>[Signature]</i> 05/01/19	<i>[Signature]</i> 05/01/19	<i>[Signature]</i> 5/1/19	<i>[Signature]</i> 05/01/19

MASTER COPY

**MASTER COPY**