



**Kerala State Drugs and Pharmaceuticals Ltd.**  
a government of Kerala enterprise

factory & office | phone : 0477-2258184  
kalavoor - 688 522 | 0477-2258828  
alappuzha, india  
Email : ksdpltd@gmail.com | fax : 0477 - 2258162  
Website : www.ksdp.co.in

KSDP/PS/F-EPRO/Vials-04/2024-25/169

28.01.2025

### **Notice Inviting e-Tender**

The Managing Director, Kerala State Drugs & Pharmaceuticals Ltd, Kalavoor – PO, Alappuzha, Kerala 688 522 invites online bids in **two** cover system for the **Supply of Type 1 Clear Glass Vials 20ML Vials-270000 Nos** from Suppliers / Organizations who have successfully completed similar works / supplies as given elsewhere in the condition of contract.

1	Name of work	<b>Supply of 20ML Vials-270000 Nos</b>
2	Earnest Money Deposit (EMD)	<b>₹14229</b> (by online; refundable)
3	Tender Submission Fee	<b>₹2596</b> (by online; non-refundable)
4	Period of completion	15 days
5	Classification of Bidder	From reputed suppliers/organisations with at least 3 years consistent standing in the field.
6	Tender documents	Can be downloaded from the site <a href="http://www.etenders.kerala.gov.in">www.etenders.kerala.gov.in</a> .
7	Last date and time of Receipt of Tender/ Bids	<b>05.02.2025, 10.00AM</b>
8	Date and Time of Opening of Tender (Technical Bid). Tender documents and tender schedule may be downloaded from the web site <a href="http://www.etenders.kerala.gov.in">www.etenders.kerala.gov.in</a> .	<b>06.02.2025, 10.00AM</b>

**NOTE: The Tenderer reserves the right to apportion the tendered quantity among bidders participated**

The bid submission fee shall be remitted online during the time of bid submission.

Those bidders possessing valid “**Udyog Aadhar**” can avail EMD & Tender Cost exception by uploading relevant document. All bid/tender documents are to be submitted online only and in the designated cover(s)/envelope(s) on the e-Tenders website. Technical bid and financial bid shall be submitted in online covers. Tenders/ bids will be accepted only through online mode on the website and no manual submission of the same will be entertained. Late tenders will not be accepted. The scanned copies of registration certificate and EMD exemption certificate (if any) and other documents as specified in the general condition shall be submitted online. More details on Tender documents/bid submission fee are mentioned in the Tender Document. The technical bids/Financial bids shall be opened online on specified date and time. If the tender opening date happens to be on a holiday or nonworking day due to any other valid reason, the tender opening process will be done on the next working day at same time and place. Tenders/ bids received online without the fee will not be considered and shall be summarily rejected. Further details on e-tender process can be had from the NIC, Thiruvananthapuram or Office of the Managing Director, KSDP Ltd, Kalavoor, Alappuzha during working hours. The KSDP Ltd will not be responsible for any error like missing of schedule data while downloading by the Bidder.

Sd/-

**Managing Director**



KERALA STATE DRUGS AND PHARMACEUTICALS LTD,  
KALAVOOR PO, ALAPPUZHA, KERALA-688522

**Packaging Material Specification**

Name of the Material: **20ML VIAL**





SOP No:	KSDP/SOP/SPEC02	Spec. No:	VIAL-20ML
Effective date:	01/01/2019	Revision No:	01

20 ml flat bottomed vials made of USP type I Flint glass of uniform surface finish without having bubbles and blow holes or apparent strains.

Height	: (57.0-58.0)mm
Over flow volume	: (26-28)ml
Outer body diameter	: (31.60-32.40)mm
Mouth OD	: (19.70-20.10)mm
Mouth ID	: (12.50-12.90)mm
Neck ID	: (16.60-17.40)mm
Height from base to constriction	: (35.25-35.75)mm
Weight	: (27-28) gm

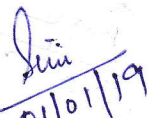
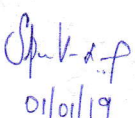
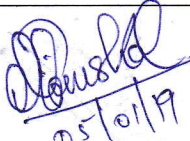
The vial should comply with all chemical tests specified in the Indian pharmacopoeia. The supplier should submit samples physically and it should pass the performance test.

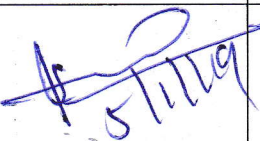
Drawing attached

Prepared by	Checked By	Reviewed By	Reviewed By	Approved By	Authorized By
Jr. Manager QA	QC Head	Asst Manager, Production	Dy. Manager, Production	Production Head	QA Head
 01/01/19	 01/01/19	 05/01/19	 05/01/19	 05/01/19	 05/01/19

MASTER COPY

MASTER COPY



KERALA STATE DRUGS AND PHARMACEUTICALS LTD,  
KALAVOOR PO, ALAPPUZHA, KERALA-688522

Name of the Material: 20ML VIAL

SOP No:	KSDP/SOP/SPEC02	Spec. No:	VIAL-20ML
Effective date:	01/01/2019	Revision No:	01

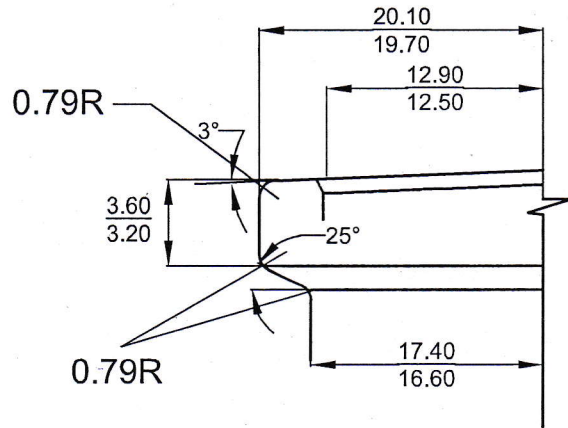
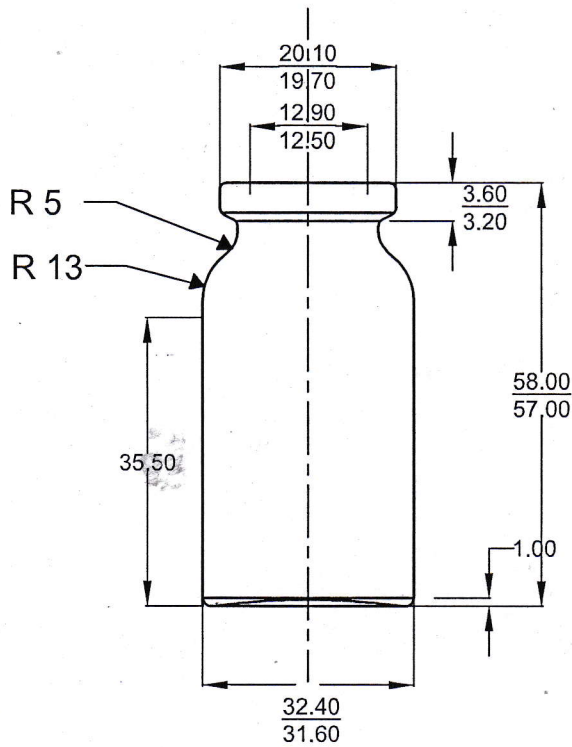

NECK FINISH DETAIL

Prepared by	Checked By	Reviewed By	Reviewed By	Approved By	Authorized By
Jr. Manager QA	QC Head	Asst Manager, Production	Dy. Manager, Production	Production Head	QA Head
<i>[Signature]</i> 01/01/19	<i>[Signature]</i> 01/01/19	<i>[Signature]</i> 05/01/19	<i>[Signature]</i> 05/01/19	<i>[Signature]</i> 5/1/19	<i>[Signature]</i> 05/01/19

MASTER COPY

MASTER COPY